

# Installation Instructions and User Guide



## Winflow<sup>™</sup>

**Model:** 72750 Classic bathroom wall mount fan heater

Electrical Rating: 230~240 V. 50 Hz.

Whilst every effort is made to provide current information at the time this Installation Instructions and User Guide was produced, continuing product improvements mean the enclosed specifications, images and literature may differ from what is actually available.

# Welcome

Thank you for buying this IXL Winflow Classic bathroom fan heater. Please read this user guide before using this one:

- You and your family, property and home will be safe from harm.
- You will learn how this appliance may differ from others.
- By using the Winflow Classic bathroom fan heater fully and properly, you will get maximum life and value from it.
- Our warranty depends on you using the Winflow Classic bathroom fan heater according to this user guide.
- It will only take you a few minutes, so please read on!

## Contents

<b>Introduction</b>	<b>Pg 3</b>
<b>Safety Precautions</b>	<b>Pg 4</b>
<b>Unpacking Your Heater</b>	<b>Pg 5</b>
<b>Choosing a Proper Location</b>	<b>Pg 6</b>
<b>Care and Maintenance</b>	<b>Pg 7</b>
<b>Cleaning</b>	<b>Pg 9</b>
<b>Warranty</b>	<b>Pg 10</b>
<b>Warranty Registration</b>	<b>Pg 12</b>

**CAUTION!**

**READ ALL SAFETY PRECAUTIONS AND INSTRUCTIONS CAREFULLY BEFORE INSTALLATION AND OPERATION.**

# Winflow

## Introduction





### Congratulations on your choice

Thank you and we are delighted you have chosen this Winflow Classic bathroom fan heater for your home. Please read all instructions carefully before assembly and use.

### Safety Notices

A WARNING / CAUTION notice denotes a hazard. It calls attention to an installation procedure, operating procedure, maintenance procedure, or the like, that if not correctly performed or adhered to, could result in damage to this product, personal injury or death. Do not proceed beyond a WARNING / CAUTION notice until the indicated conditions are fully understood and met.

### Safety Symbols

	Alternating current
	Protective earth
	Warning/Caution
	Double Insulated

### Product Specifications

Model	Operating Voltage	Operating Frequency	Heater Power Low setting	Heater Power Low setting
72750	220-240V~	50Hz	1200W	2400W

### Safety Feature

This appliance comes with an intergrated over-heating protection feature. The fan will be automatically switched off when internal temperature of the product exceeds 75°C.

Please observe the following general safety precautions carefully before and during all phases of handling, installation, removal, operation and maintenance of this product. Failure to comply with these precautions violates safety standards of design, manufacture and intended use of the product. IXL Home assumes no liability for customer's failure to comply with these requirements.

## WARNING

1. Read all instructions and safety information.
2. Review assembly diagrams provided before installing your new bathroom heater.
3. All electrical work (i.e., Installation of wall socket, etc.) must only be undertaken after disconnection of the power by removing fuses or turning off the circuit breaker, to ensure all pole disconnection from the supply mains **by a licensed electrician, and all electrical work must be carried out in accordance to AS/NZS 3000 Wiring Rules and applicable local authority regulations.**
4. Always apply common sense and practice care during installation and operation.
5. This product is not intended for use by persons (including children) with reduced physical, sensory or mental capabilities, or lack of experience and knowledge, unless they have been given supervision or instruction concerning safe use of the product by a responsible person.
6. Children should be supervised to ensure that they do not play with the product.
7. The heater is to be installed in a location so that the switches and other controls CANNOT be touched by a person in the bath or shower.
8. Do not install the heater directly above shower cubicle or bath enclosure.
9. DO NOT INSTALL IN AN AREA WHERE WATER MAY BE SPLASHED ON THE APPLIANCE.
10. Do not install the product close to curtains and other combustible materials.
11. **The product must, under no circumstances, be covered with insulating material or similar material on the front, sides or rear of the unit to avoid overheating.**
12. This product must be installed so that the relevant national regulations and Australian Building Code requirements concerning ventilation and the discharge of air are fulfilled.
13. Do not leave heater unattended when it is ON.
14. Do not leave heater on overnight
15. Never obstruct or block an opening of the heater.
16. This product is a double insulated appliance.
17. If the supply cord becomes damaged, it must be replaced by a qualified person (electrician) in order to avoid a hazard.
18. Use a power cable with a minimum 10A rating.
19. Do not use the heater if any part of the heater is broken or damaged.
20. Check and confirm after the product is completely installed that all connections are proper and secure to prevent the product from falling, causing property damages or injury.
21. Do not probe through the fascia opening.
22. To ensure trouble-free performance, it is recommended that the unit be unplugged from the wall outlet and a vacuum cleaner used to remove dust and fluff from the inlet and outlet grilles on a regular basis.
23. Do not use electronic, solid-state or wall controllers with dimmers.
24. Do not install or use the product outdoor where it could be exposed to water or moisture (indoor use only).
25. This manual is not intended to instruct or assist untrained or unqualified persons to install this product.

Open the original carton and verify the below items were supplied in packaging. If there are any missing or mechanically damaged items, contact IXL Customer Care. Do not throw away the carton or other packaging material as it may be needed if warranty replacement or repair is ever necessary.

- 1 x pre-assembled Winflow Classic wall mounted bathroom fan heater
- 1 x Installation Instructions and User Guide with warranty information

**How to choose a proper location for heater**

This appliance **MUST** be installed in accordance with relevant wiring rules and regulations which cover installation of appliances and accessories in damp situations, such as bathrooms, showers, laundries and other areas with fixed water containers (in Australia and New Zealand -AS/NZS3000:2018 Wiring Rules).

1. The product must be mounted on a flat wall (Not for ceiling mounting).
2. The heater is to be installed in a location so that the switches and other controls **CANNOT** be touched by a person in the bath or shower.
3. Do not install the heater directly above shower cubicle or bath enclosure.
4. **DO NOT INSTALL IN AN AREA WHERE WATER MAY BE SPLASHED ON THE APPLIANCE.**
5. **DO NOT INSTALL** a wall socket directly below appliance.
6. The heater must be mounted at a minimum distance of:
  - a. 1800mm from floor
  - b. 150mm below the ceiling
  - c. 250mm from adjacent walls
  - d. 500mm between the heater and any objects heated below it.
  - e. 1000mm between the sides of the heater and the sides of any adjacent heater, as well as at least 1000mm away from curtains and other combustible objects.
7. Ensure the wall is strong enough to support the weight of at least 10 kg.

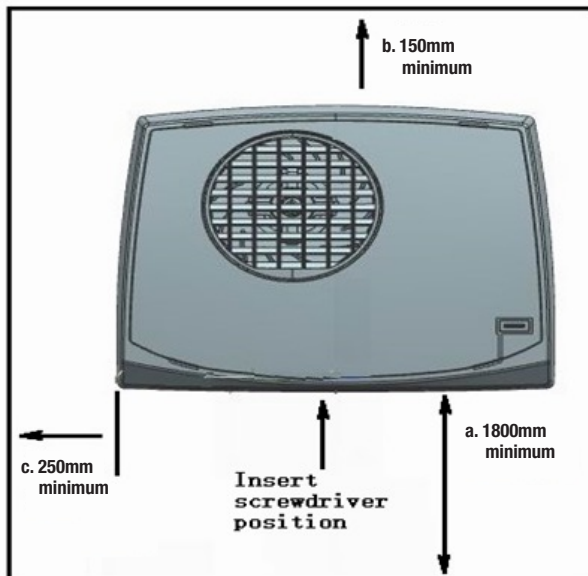

The air is sucked in, blown over heating elements and then blown out through the lower grille into the bathroom. The heater functions (On/Off, temperature adjustments) are controlled by the pull-cord switch.

**Fixing to Wall**

1. Select a location for mounting of the heater.
2. Place the Wall Mounting Baseplate on wall as shown in Figure 1 and mark screw positions.
3. After marking screw positions, secure the Wall Mounting Baseplate with 4 screws.
4. Connect the Bathroom heater on the Wall Mounting Baseplate.
5. Make sure the heater is locked in place on the Wall Mounting Baseplate for safe operation.
6. If there is a requirement to remove the heater from the wall Mounting Baseplate, isolate power by unplugging the heater from the wall socket. Then insert a small screwdriver into the hole located on below outlet of the heater as shown in Figure 3.

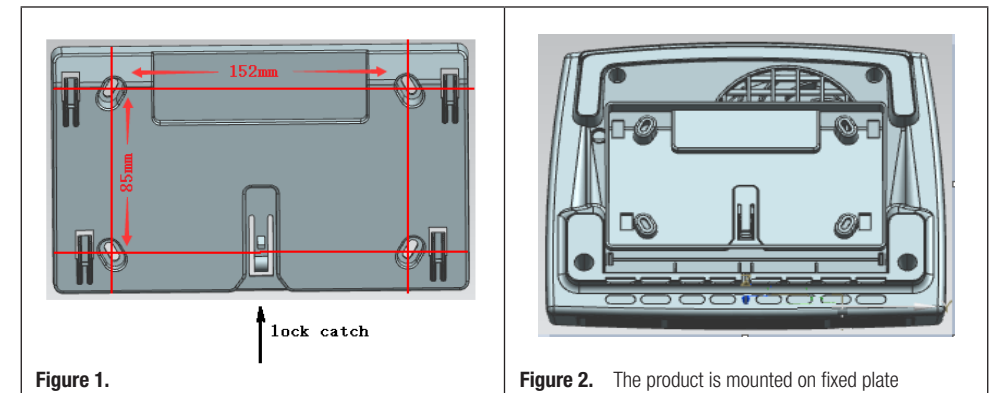

Figure 1.

Figure 2. The product is mounted on fixed plate

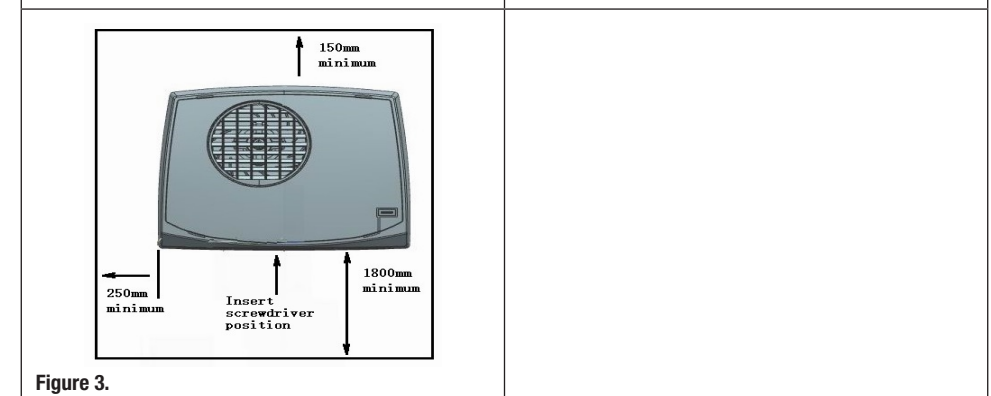

Figure 3.

**Operating Instructions**

1. Pull the cord once to start the heater at LOW heat setting (1200W).
  - a. The LED indicator light will illuminate.
2. Pull the cord twice to set the heater to HIGH heat setting (2400W)
  - a. The LED indicator illuminates at brighter setting.
3. Pull the cord again to turn the heater OFF.

**Safety Cutout**

Your Winflow Classic bathroom fan heater is fitted with an auto-reset thermal cutout and a fusible link. Either of these devices will automatically switch off the elements, should the unit reach an abnormal temperature. This is very unlikely to happen in normal use other than in very abnormal conditions. However, should this occur:

- Unplug the bathroom heater from power supply.
- Check for blockage of the air inlet and outlet.
- Use a vacuum cleaner to clean if necessary.

If the heater still fails to operate, contact IXL Customer Care.

**WARNING!**

- a. Make sure the appliance is unplugged at the mains power socket before commencing work.
- b. Allow the appliance to cool completely before commencing work.

1. After power is turned off and the Winflow Classic bathroom fan heater is cool, wipe the outer surface with a clean cloth dampened with petroleum-free detergent or liquid glass cleaner. Do not use alcohol cleaner, or thinner or liquid that is corrosive to plastic for cleaning.
2. Dry the product completely before re-use.
3. To ensure trouble-free performance, it is recommended a vacuum cleaner be used to remove dust and fluff from the inlet and outlet grilles on a regular basis.



**PLEASE RECYCLE ALL PACKAGING MATERIAL SUPPLIED WITH THIS PRODUCT**

**12 Month Warranty**

This Warranty against defects for your newly purchased IXL product is proudly prepared by IXL Home Pty Ltd of 1K Marine Parade, Abbotsford, VIC 3067, phone 1300 727 421.

1. Winflow Classic bathroom fan heaters come with guarantees that do not exclude the following consumer entitlements under the Australian Consumer Law:
  - a. replacement or refund for a major failure and compensation for any other reasonably foreseeable loss or damage; and
  - b. to have the goods replaced if goods fail to be of acceptable quality and the failure does not amount to a major failure.
2. IXL Home warrants that your product and related supply will be free from defects in materials and workmanship during the warranty term.  
Your warranty term is 12 months commencing from the date of purchase.
3. Subject to Point 1, IXL Home will during the warranty term provide a replacement of an equivalent current model where the balance of the warranty period from the original date of purchase will take effect.
4. To the fullest extent permitted by law and subject always to Point 1, IXL Home will not be liable for:
  - a. any loss or damage arising from loss of use, loss of profits or revenue; or
  - b. for any indirect or consequential loss or damage resulting from any breach of this warranty against defects.
5. Defective IXL products may be replaced by a refurbished product of the same type.

**Limitations to Your IXL Warranty**

6. Subject to Point 1, this Warranty:
  - a. will only be provided to the original purchaser where the original purchase was made from a IXL Home Authorised Dealer or Reseller and proof of such purchase can be presented at the time of service;
  - b. only applies to IXL products purchased in Australia and New Zealand from an IXL Home Authorised Dealer or Reseller;
  - c. will not apply where the defect in or failure of the product is attributable to misuse, abuse, accident or non-observation of the manufacturer's instructions. This product must be used in accordance with the manufacturer's instructions;
  - d. will not cover faults due to normal wear and tear with reasonable use nor consumable components such as globes, filters, glass items etc;
  - e. will not cover any damages or problems caused to this product by natural forces eg. storm, fire, flood, and earthquake; or by intrusion or accumulation (or both) of foreign matters eg. dust, soil, and moisture. IXL Home recommends that you take out appropriate insurances to protect your product to this end;
  - f. will not apply if this product is installed in a mobile dwelling eg. caravan or boat;
  - g. will not apply if this product is removed from the location where it was first installed;
  - h. covers use of this product for domestic use only;
  - i. will not be restarted or extended upon replacement of the product or a part.

**How to make a claim under your IXL Warranty**

7. To make a claim under this Warranty you will need to:
  - a. contact IXL Home customer service department on 1300 727 421 or [service@ixl.com.au](mailto:service@ixl.com.au) for Australia and 0800 727 421 [service@ixlhome.co.nz](mailto:service@ixlhome.co.nz) for New Zealand to provide details and register your claim enabling a IXL Home assessment;
  - b. submit proof of purchase with your claim eg. tax invoice or purchase receipt;
  - c. where a property has been constructed by a builder/developer and it is fitted with IXL products, please submit proof of purchase by way of the certificate of occupancy, with your claim.

**Privacy**

The privacy of your personal information has always been important to us. To learn more about how we collect, keep and use your personal information, please obtain a copy of our privacy statement by visiting our website at: [www.ixlappliances.com.au](http://www.ixlappliances.com.au) or by contacting us via email on [service@ixl.com.au](mailto:service@ixl.com.au) or by telephone on 1300 727 421.



**Visit IXL Home website below to register your warranty details online.**

**Australia**

[www.ixlappliances.com.au/warranty](http://www.ixlappliances.com.au/warranty)

**New Zealand:**

[www.ixlappliances.co.nz/warranty](http://www.ixlappliances.co.nz/warranty)

For comments, questions or warranty matters:

**IXL Home Pty Ltd**

**Australia**

**Free Call:** 1300 727 421  
[service@ixl.com.au](mailto:service@ixl.com.au)  
[www.ixlappliances.com.au](http://www.ixlappliances.com.au)

**New Zealand:**

**Free Call:** 0800 727 421  
[service@ixlhome.co.nz](mailto:service@ixlhome.co.nz)  
[www.ixlappliances.co.nz](http://www.ixlappliances.co.nz)

